



 OAKCASTLE

CD-150

---

USER MANUAL

Contents .....	2
Accessories .....	3
Buttons Instruction .....	4
Remote Control .....	5
Button Operation .....	6
Basic Operation .....	7
Bluetooth Mode Instructions .....	8
USB Mode Instructions .....	8
FM Mode Instructions .....	9
Troubleshooting .....	10
Installation Instantious .....	11
Product Features & Warranty .....	11
Safety Information .....	12

**3** | YEAR  
WARRANTY

Register your product online for a FREE 3 year  
extended warranty at: [www.oakcastle.co.uk](http://www.oakcastle.co.uk)

## Accessories



Oakcastle CD150 Wall CD Player



Remote control



Pack of screws



User Manual



USB to Type-C charging cable



Wall-mounted plate



Desk stand

## Buttons Instruction

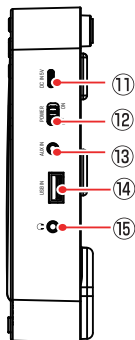
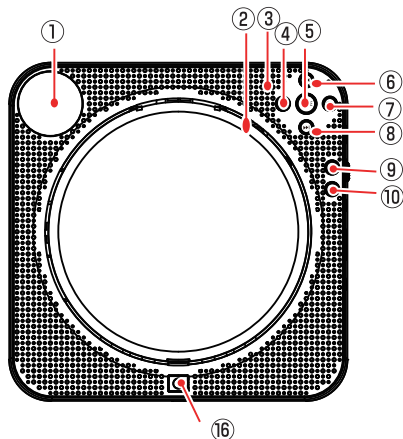

1. Status display
2. Remote control light sensor
3. Light charging LED
4. VOL-
5. Mode
6. Previous
7. VOL+
8. Next
9. Pause/Play
10. Stop
11. DC IN 5V
12. Power ON/OFF switch  
(Push the cable)
13. AUX IN
14. USB IN
15. Earphone
16. CD cover Open button

## Remote Control

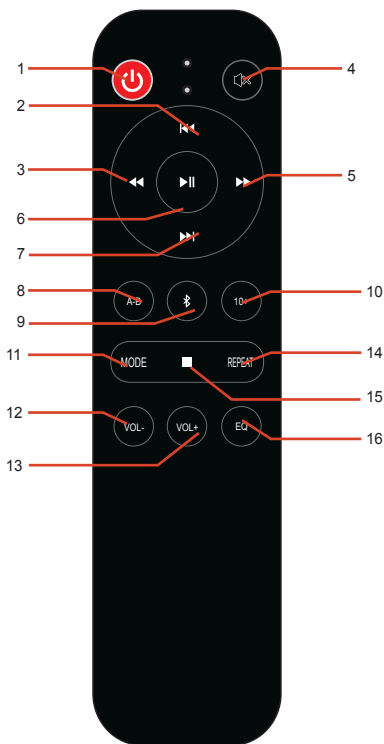

Item	Function
1	Standby
2	Previous
3	Fast Rewind
4	Mute
5	Fast Forward
6	Pause/Play
7	Next
8	A-B
9	Bluetooth
10	Number 10+
11	MODE
12	VOLUME -
13	VOLUME +
14	Repeat
15	Stop
16	EQ

## Button Operation

### 1. STANDBY

When the power on, turn the unit on/off.

### 2. Number Pad (10+)

Press this button to enter the 10+ songs such as 10,20,30,etc.

### 3. PLAY/PAUSE

Press PAUSE button to pause playback.

Press it again to continue playing from where it was paused.

### 4. STOP

Press STOP button to stop playback.

Press PLAY Button to play from the beginning.

### 5. MUTE

Press to mutes the audio output on the player.

### 6. VOL+/VOL-

Press to increase or decrease the volume output.

### 7. MODE

Press to change the playing mode.

### 8. PROGRAM

PROGRAM button apply for CD, USB, AUX, Bluetooth, FM Radio, MP3, WMA & HD-CD. This function allows you randomly assign 20 songs (max) and play them in order.

### 9. AUX IN

Connect it with the AUX output device(such as DVD player, CD player or Mobile phone etc) via AUX cable.

## Basic Operation

### 1. How to Turn the Player on/off.

- A.the power switch is located on the side. Please toggle it to ON position to play normally.  
 B.the power switch is located on the side. Please toggle it to OFF position to turn it off.

### 2. How to Charge for the Player

Connect the supplied USB charging cable with the power adapter, then plug it into a power source to charge the player. OR Connect the supplied USB Charging cable to a computer/ desktop/car charger/power bank to charge it.

Charging Time: It will take about 4 hours for a full charge. When charging, the charging indicator on the player will be RED. Once the player is fully charged, the indicator will turn to GREEN.



NOTE: When the player is in low battery, the LCD screen will be flashing. Please charge it.

### 3.How to setup the Circle Mode

Each time the REPEAT button on the remote control is pressed, the order of the tracks played will be as follows:Repeat1(REP1), Repeat all(ALL), random play(SHUF).



### 4. How to Program the Play

Press the PROG button to enter the programming mode when the play stops, press the PREVIOUS or NEXT button to select the track you want to program, press PROG again to confirm the programming.

Up to 20 tracks can be programmed in this mode. After that, press the PLAY button to enter the programming play mode. Press the STOP button directly to enter the stop mode to cancel or reprogram.



### 5.. How to setup EQ effect

Press the EQ button to changes the different sound effects. There are a total of 5 sound effects: BBS, POP, JAZZ, ROCK, and CLASSIC,FLAT.



### 6. A-B Repeat

- A. During playback press "A-B" to set the Starting Point A.  
 B. Press "A-B" a second time to set the Ending Point B and player will repeatedly play the part between Point A and Point B.  
 C. Press "A-B" a third time to cancel "A-B" repeat and resume normal playback.



A-B Repeat Starting Point



A-B Repeat Ending Point



A-B Repeat Cancelled

## Bluetooth Mode Instructions

1. Press the "MODE" button to switch to Bluetooth mode, the "BT" will show on the LED display, then the unit will be ready to pair other Bluetooth devices such as mobile phone, pads etc.
2. Activate the Bluetooth in your mobile phone and it will automatically search nearby Bluetooth device to pair.
3. Choose the name " HCD-12 " device in your mobile phone Bluetooth device list to pair.
4. Your mobile phone will be paired/connected to the CD player in a few seconds.
5. Playing music on your mobile phone and the audio will be transmitted to the CD player speaker through Bluetooth.

### Note:

This Player isn't compatible with Bluetooth headsets, Bluetooth speakers and Car's Bluetooth.

## USB Mode Instructions



1. Plug in a USB-stick to the CD player USB port.
2. Press the "MODE" button to switch to USB mode.
3. The CD player will read and play the music in the USB-stick automatically.

### Note:

1. Supports a maximum 32GB USB flash drive, which must be FAT32 format.
2. If can't read the USB-stick, please check the format and capacity. If not FAT32 format, please format it to FAT32.



## FM Mode Instructions

1. Press the "MODE" button to switch to FM radio mode.
2. Press the  button to go to auto searching, the channels will be automatically stored when searching channels.
3. After auto searching finished, press  or  button to adjust channels. (Note : the channels storage capacity is 40 channels. P1-P40)

## Troubleshooting

Problem	Reason	Solution
<b>Cannot be turned on</b>	Switch is not turned on.	Press the ON/OFF button.
	HOLD is turned on.	Press the HOLD button.
	The battery is exhausted.	Charge the battery.
	The player is damaged.	Please contact Oakcastle Tech Support.
<b>Cannot read discs</b>	The disc is installed incorrectly.	<ol style="list-style-type: none"> <li>1. Make sure the label side of the disc is facing up.</li> <li>2. Ensure disc is inserted fully.</li> </ol>
	The disc cannot be recognised.	The player is only compatible with CD, CDR, MP3 & HDCD
	The disc is dirty or damaged.	<ol style="list-style-type: none"> <li>1. Make sure the disc is not heavily scratched or damaged.</li> <li>2. Wipe the disc gently from the centre towards to the edge of the disc with a clean and soft cloth.</li> <li>3. Try another disc to check if the disc is faulty.</li> </ol>
	The loader is dirty.	Wipe the lens gently with a degreasing cotton swab.
<b>Cannot charge battery</b>	There is no current at power outlet.	Make sure the power outlet is working.
	The plug is not plugged in correctly.	Make sure that the two plugs of the power cords are connected correctly.
	The charger is damaged.	Replace a charger with one that matches the original specification (DCSV/1A).
	The player is damaged.	Please contact Oakcastle Tech Support. NOTE: While charging, make sure the Power Source and the Charging Voltage are DCSV/1A. Excessive voltage input may cause machine overload damage.
<b>Automatically skips parts of the contents of the disc</b>	The player has MODE function (Repeat, Repeat All, Random Play& Preview Play).	Please ensure Preview Play MODE is off.
<b>Noisy &amp; Screaming when it plays</b>	Usage time of the disc may be too long, so the disc is not smooth.	<ol style="list-style-type: none"> <li>1. Make sure the disc is not heavily damaged.</li> <li>2. Wipe the disc gently from the centre towards to the edge of the disc with a clean and soft cloth.</li> <li>3. Try another disc to check if the disc is faulty.</li> <li>4.</li> </ol>
	If there is a scratching sound from inside of the CD player this might be caused due to the CD not being inserted correctly.	Please change to another disc, and do not use the other one again.

## Installation Instructions

1. Fix the wall-mounted plate on the wall with 4 screws (included in package).
2. Hang the CD player on the wall-mounted plate.

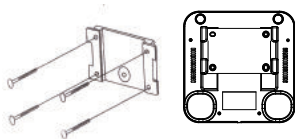

## Product Features

Model	CD150
Frequency response	20-22KHz
Power output of earphone	16mW+16mW/16-32Ohm
Impedance of earphone	32Ohm/16mW
Compatible Disc	CD/CDR/HDCD/MP3/WMA
Bluetooth	Bluetooth Speaker, Version: 4.2
HIFI Speaker	Support EQ function 3Wx2
USB	Support MAX 32G/ FAT 32 Format
Battery	Rechargeable battery 3.7V 2000mAh , Support about 3 hours
Power source	Micro USB 2.0 Standard
Power consumption	about 10W
Dimensions (L*W*H)	165x165x45mm
Weight	502.4g

## WARRANTY

All products come with a standard 12 month warranty. All items must be registered on [www.oakcastle.co.uk](http://www.oakcastle.co.uk) for the warranty to be valid. Once on the web page, use the menu to find "register your product". You will also be given the chance to extend your warranty for an additional 24 months, free of charge.

1. Read these instructions.
2. Keep these instructions. Instructions are also available for download at [www.oakcastle.co.uk](http://www.oakcastle.co.uk)
3. Heed all Warnings
4. Follow all instructions
5. Do not clean the apparatus near or with water
6. Do not block any ventilation openings. Install in accordance with the manufacturer's instructions
7. Do not install near any heat sources such as radiators, heat registers, stoves, or other apparatus (including amplifiers) that produce heat.
8. Protect the power from being walked on or pinched particularly at plugs, convenience receptacles, and the point where they exit from the apparatus.
9. Only use attachments/accessories specified by the manufacturer.
10. Unplug this apparatus during light storms or when unused for long periods of time.
11. Refer all servicing to qualified service personnel. Servicing is required when the apparatus has been damaged in a way, such as power-supply cord or plug is damaged, liquid has been spilled or objects have fallen into the apparatus, the apparatus has been exposed to the rain or moisture, does not operate normally or has been dropped.
12. No naked flame sources, such as lit candles, should be placed on the apparatus.
13. Dispose of used electrical products and batteries safely according to your local authority and regulations.

#### ADDITIONAL WARNINGS

The apparatus shall not be exposed to dripping or splashing and no objects filled with liquid, such as vases, shall be placed on the apparatus. Main plug is used to disconnect device and it should remain readily operable during intended use. In order to disconnect the apparatus from the main mains completely, the mains plug should be disconnected from the main socket outlet completely. Battery shall not be exposed to excessive heat such as sunshine, fire or the like.



#### RECYCLING ELECTRICAL PRODUCTS

You should now recycle your waste electrical goods and in doing so help the environment.

 This symbol means an electrical product should not be disposed of with normal household waste. Please ensure it is taken to a suitable facility for disposal when finished with.

**IMPORTANT:** Please read all instructions carefully before use and keep for future reference.



Risk of electric shock.  
Do not open



Read all instructions carefully before use and keep for future reference



When servicing, use only identical replacement parts



#### CAUTION

RISK OF ELECTRIC SHOCK  
DO NOT OPEN



#### ATTENTION

RISQUE D'ELECTROCUTION  
NE PAS OUVRIR



**IMPORTANT:** Please read all instructions carefully before use and keep for future reference

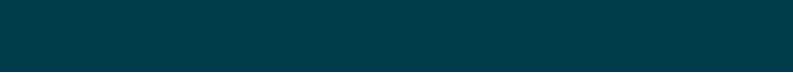







[WWW.OAKCASTLE.CO.UK](http://WWW.OAKCASTLE.CO.UK)