



 OAKCASTLE

SB-200

USER MANUAL

Contents.....	2
Box Contents	3
Controls & functions.....	4
How to Connect.....	7
Getting Started.....	8
Basic Operations.....	9
Organising Channels & Stations.....	11
USB/Multimedia & Recording.....	12
Electronic Program Guide.....	15
Scanning & Rescanning.....	16
Audio Language & Format.....	17
Audio-Visual Settings & Options	18
Parent Controls & Auto-Power On.....	19
System Maintenance.....	20
Factory Reset & Software Update.....	21
Network Settings & Apps.....	22
Troubleshooting.....	23
Spec & Warranty	24
Safety Information.....	25

3 | **YEAR**
WARRANTY

Register your product online for a **FREE** 3 year
extended warranty at: www.oakcastle.co.uk

WHAT'S IN THE BOX

- A. Oakcastle SB200 HD Freesat Recorder
- B. Instructions Guide
- C. Remote Control (and 2 x AAA batteries)

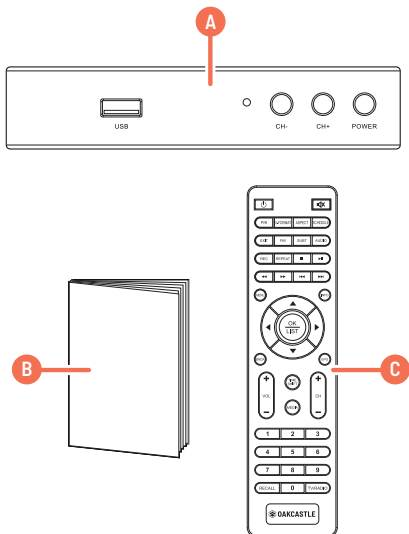

REMOTE CONTROL

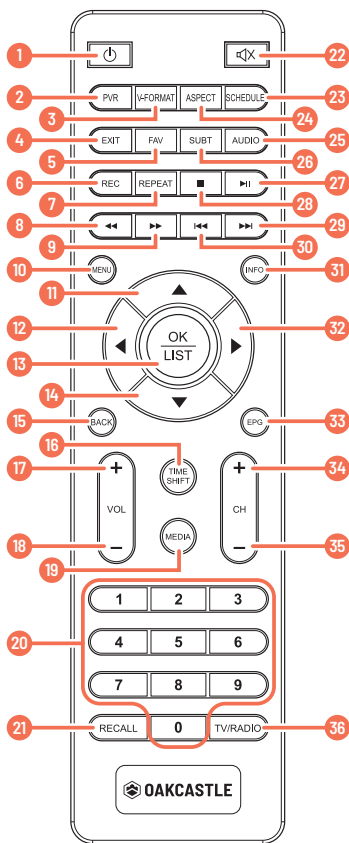

1. **Power on/off**
2. **PVR button** (access PVR menu)
3. **V-Format:** change TV resolution
4. **Exit:** Exit to top menu
5. **Fav:** Add favourites
6. **Rec:** Start recording (Press Menu to stop)
7. **Repeat:** Repeat USB file
8. **Rewind**
9. **Fast forward**
10. **Menu:** Display/return to menu
11. **Up**
12. **Left**
13. **OK/Select**
14. **Down**
15. **Back:** Go back
16. **Time Shift:** pause live TV (requires USB stick with sufficient storage)
17. **Volume +**
18. **Volume -**
19. **Media:** press to access USB content
20. **Number keypad**
21. **Recall:** Go to previous channel
22. **Mute/Unmute**
23. **Schedule:** Schedule recording
24. **Aspect:** Change aspect ratio
25. **Audio:** Change audio settings
26. **Subt:** Subtitles on/off
27. **Pause/play**
28. **Stop**
29. **Skip forwards:** Go to end of film/music file or show next photo
30. **Skip backwards:** Back to previous file/start of film or music file
31. **Info:** show programme info
32. **Right**
33. **EPG:** Electronic Program Guide
34. **CH+:** Next channel
35. **CH-:** Previous channel
36. **TV/Radio:** Switch modes

CONTROL BUTTONS

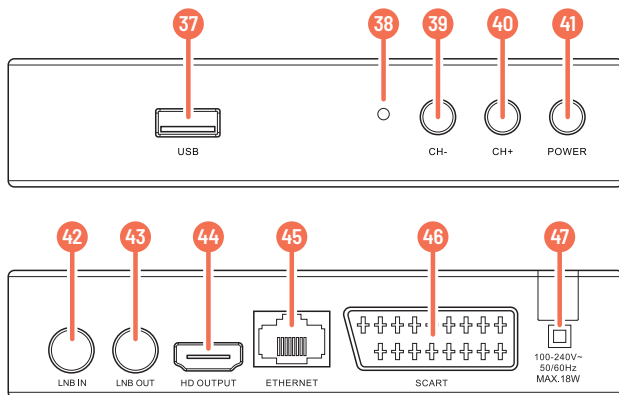

- | | |
|-------------------------|----------------------|
| 37. USB Port | 44. HDMI port |
| 38. Standby Light | 45. Ethernet Port |
| 39. CH- (prev. channel) | 46. Scart Connection |
| 40. CH+ (next channel) | 47. Power Supply |
| 41. Power on/off | |
| 42. LNB IN | |
| 43. LNB OUT | |

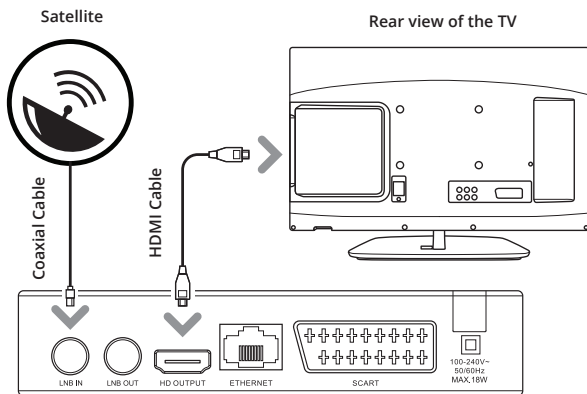

Connection

Refer to the diagram above for the connection of your Freesat box to your satellite and TV using the HDMI slot.

Step 1: Connect your antenna lead to the TV LNB IN port (**Ref.42**).

Step 2: Choose an installation method (HDMI (**Ref.44**) or SCART (**Ref.46**)) and follow the steps below.

HDMI - connect an HDMI cable between your TV and the device. HDMI incorporates both audio and video so there is no requirement to make separate connections for audio.

SCART - if your TV does not have an HDMI slot, you can connect using the SCART connection (**Ref.46**).

Steps for getting started with your Freesat Box

Turn on your TV.

Plug the STB (Set Top Box) device into the mains.

Connect the STB to your TV using an HDMI cable or SCART cable (See page 7 for details).

Select the correct source/video or AV input channel for the HDMI input. This can be done by pressing the TV/AV or VIDEO button on your TV remote control. (Refer to your TV user's manual for instructions).

The welcome screen will appear, followed by a message asking if you would like to automatically search for channels and stations.

To automatically search for available channels and stations, press OK on the remote control (**Ref.13**). The auto search window will appear and searching begins. If you want to search for channels and stations yourself, see 'Manual Searching' on page 17 for instructions and follow the steps described.

Once the search is complete, the device will automatically begin playing one of the TV channels found.

Selecting a channel

Follow one of the methods below to switch channels.

Press up or down on the navigation controls (**Ref.11/Ref.14**) to move to the next or previous channel.

If you already know the channel number, enter the number using the number keypad (**Ref.20**) and then press OK (**Ref.13**) or wait for 2 seconds.

Press OK (**Ref.13**) on the remote control. This will display the channel/radio station list.

Press up or down until the channel you want is highlighted, and then press OK (**Ref.13**).

Press the EPG button (**Ref.33**), select the channel you want from the list, and press EPG (**Ref.33**) again.

NOTE: Press the RECALL button (**Ref.21**) to return to the last channel or station played.

Selecting a radio station

Press TV/RADIO (**Ref.36**) to enter radio mode, then enter the number. (For example, 201 is the number for ABC Jazz).

Press OK (**Ref.13**) to display the station list. Press up or down until the channel you want is highlighted, and then press OK (**Ref.13**).

NOTE: The STB uses the Logical Channel Numbering system (LCN) by default. Secondary channels can be selected by pressing the primary number followed by another number. (For example, pressing 2 gives you ABC1, and pressing 22 gives you ABC2).

Adjusting the volume

Press up or down on the remote control (**Ref.17/Ref.18**) to increase or decrease the volume.

Press the mute button (**Ref.22**) to mute or un-mute the sound.

Getting channel information

Press the info button (**Ref.31**) to view program information including the current and next program. The banner will stay displayed for a few seconds. To hide it, press exit (**Ref.4**) on the remote control.

Subtitles

To switch on subtitles, if they are available for the program you are watching, press SUBT on the remote control (**Ref.26**), then select the desired language and press OK (**Ref.13**).

Picture freeze/pause live TV

Press Timeshift (**Ref.16**) to pause live TV. Press again to resume. Note: this function requires USB storage space of at least 1GB by default (you can change this by navigating to PVR configure, Record Device, and then change the default storage size).

Favourites

To add a channel to your favourites list, press Menu on the remote control (**Ref.10**) to bring up the main menu. From here, select the 'Program' section from the main header. Then select 'Program Edit' by pressing down on the remote control (**Ref.14**) and press OK (**Ref.13**). Insert the password (default password is 000000). Select the channel you want to save as a favourite, press the FAV button (**Ref.5**) to bring up the favourites menu, then choose a favourite type to add it to the list. Press EXIT (**Ref.4**) to exit the menu and save your changes.

To select favourites while watching TV, press FAV (**Ref.5**).

Channel Manager

The channel manager allows you to organise channels and stations. To access the channel manager, press Menu (**Ref.10**) on the remote control. Select 'Program Edit' from the menu, and press OK (**Ref.13**). The default password is 000000. In the Channel Manager you can select from the following options:

Move

Channels are automatically stored in numerical order. To move the order of channels and stations around, under 'Program Edit' in the menu, select the channel you want to move. Press the PVR button/red button (**Ref.2**) to select and move the channel to your desired position using the arrow buttons, and press the red button (**Ref.2**) again to select and save your changes.

Lock

To lock a channel or station, press up or down (**Ref.11/Ref.14**) until the channel or station you want to lock is highlighted. Press the Aspect/yellow button (**Ref.24**) to lock or unlock a station. The default password is 000000.

Delete

Press up or down until the channel or station you want to delete is highlighted. Press the Schedule/blue button (**Ref.23**). To delete, press OK (**Ref.13**). To cancel, press EXIT (**Ref.4**).

To re-instate a channel you have deleted, you will need to rescan for channels. To do this, follow the steps under 'Scanning/Rescanning for Channels and Stations' on **page 16**.

Favourites

Please see **page 10** for instructions on how to manage your favourites.

USB Multimedia and recording

The USB function can be used to record a program, play or view files from USB. Please see page 24 for details of the types of compatible USB files.

Multimedia - Music, Photos, and Films from USB

To access the Multimedia menu section, press Menu (**Ref.10**). Press previous or next (**Ref.12/Ref.32**) until 'USB' is highlighted (this is the icon at the far right of the menu list).

To play music, view photos or watch films or recordings from USB, simply select 'Music', 'Photo', 'Movie', or 'PVR' in the menu system, and then navigate to the file(s) you would like to play/view using the navigation controls (**Ref.11/Ref.32/Ref.14/Ref.12**) on the remote control.

Note: Do not remove your USB device from the STB while it is in use during any USB multimedia function.

Record a program

To record, please follow one of the methods below. Please note that the DVR (recording) function requires any attached storage devices to be formatted as FAT32.

Method 1 - REC button

To record a TV program you are currently viewing press the REC button (**Ref.6**) to start recording. To stop recording, press STOP (**Ref.28**) on the remote. The recording will be accessible under 'Multimedia', 'PVR' in the menu. To record for a set period of time, follow the steps on page 13.

Method 2 - REC button (from EPG menu)

To set a future program to record from the EPG (Program Guide) list, highlight the program in the list, then press the 'REC' button (**Ref.6**). This will automatically fill the program details into the schedule/recording menu. From here, confirm the recording schedule. The recorded file will be accessible under 'Multimedia', 'PVR' in the menu.

Method 3 - Blue button

You can set up to eight timers on the device. Setting a timer will set the device to start and stop recording at specific times. If the device is switched off when a recording is scheduled, it will switch on to begin recording. To set the device to switch on and off again at specific times every day, please follow the steps on **page 19**.

Press the Blue SCHEDULE button (**Ref.23**) to schedule a recording. Press the Red 'PVR' button (**Ref.2**). From here, select the appropriate channel, date and time and press OK to confirm (**Ref.13**). To edit the recording settings, press the green button (**Ref.3**). To cancel a scheduled recording, ensure you are on the Schedule menu (press Schedule/Blue button (**Ref.23**) if not) press the yellow/ASPECT button (**Ref.24**) then press OK to confirm (**Ref.13**). Alternatively, press the EPG button (**Ref.33**) and press the Blue SCHEDULE button (**Ref.23**) from here. To cancel a recording, press the yellow ASPECT button (**Ref.24**).

Notes on recording

Note: During recording, only certain operations are functional (for example SUBT (**Ref.26**), FAV (**Ref.5**), Ch+ and Ch- (**Ref.34/Ref.35**), Vol+ and Vol- (**Ref.17/Ref.18**), RECALL (**Ref.21**) will still function). Changing channels and volume will still function. While one channel is being recorded, it is still possible to watch a program on a different channel.

You can also set the timer to repeat recording Once, Daily or Weekly to record shows on repeat. To do this, scroll down to 'Repeat' and use the arrows (**Ref.11/Ref.12/Ref.14/Ref.32**) to select your chosen option. Press OK to confirm (**Ref.13**).

Please note that times must be entered using the 24-hour clock format. For example, 8 o'clock in the morning is entered as 0800, while 8 o'clock in the evening is entered as 2000.

CONFIGURING PVR PARTITIONS

PVR Configure

When using an HDD (external hard drive) to record programs, in most cases you can choose from several partitions available to record onto. The set top box will allow you to choose different partitions for recording purposes.

To navigate to the PVR settings, press the Menu button (**Ref.10**), then navigate to the USB section using the left and right buttons (**Ref.12/Ref.32**). Scroll down to 'Multimedia' and press OK to select (**Ref.13**). On the Multimedia screen, scroll across to 'PVR' and press OK to confirm (**Ref.13**). Use the up or down arrows (**Ref.11/Ref.14**) to choose the partition you want to use, and press OK (**Ref.13**) to save your choice. Recorded program files will be saved in a folder called 'OakcastleRecordings'.

Some providers broadcast information about their programs. This information is available on screen via an electronic program guide, displayed by pressing EPG (**Ref.33**) on the remote control. You can navigate through the EPG and view information about channels and programs (explained in the next section) or press EPG (**Ref.33**) or EXIT (**Ref.4**) to close the guide.

Displaying program information

The information displayed when you press EPG (**Ref.33**) relates to the channel that is showing at the time. At the right of the screen is information about the current channel list, and at the left of the screen is a list of upcoming programs.

To display information about the programs on another channel, press right or left (**Ref.32/Ref.12**) until the channel you want information about is highlighted at the left of the screen.

Selecting a channel to watch from the EPG

With the channel name panel selected, press left or right (**Ref.12/Ref.32**) until the channel you want to watch is selected.

Scheduling a recording via EPG

To record a program from the EPG, first press the EPG button (**Ref.33**). Then press the blue button (**Ref.23**) to schedule a recording.

The Channel Search option on the main menu enables you to scan for and detect digital TV and radio stations available in your area. You will need to perform a rescan if:

- New channels or stations become available
- If you want to reinstate a channel or station you have deleted, or:
- If you move to a new location.
- You can either perform an automatic scan to automatically scan for and detect new stations, or a manual scan to search for a specific channel or all channels from a specific broadcaster.

Automatic Search

1. Press MENU (**Ref.10**) on the remote control.
2. Scroll down to 'Auto Search' and press OK (**Ref.13**). The device will begin automatic channel search. Please wait a few minutes for the device to scan for channels. Once the scan is complete, the first available channel will begin playing.

Manual Searching

Note: Automatic searching (described above) is suitable in most cases. You might use the manual search option if you have deleted a channel and now want to access it again. In this case, you would just search for that particular channel.

1. Press MENU (**Ref.10**) on the remote control.
2. Scroll down to 'Manual Search' and press OK (**Ref.13**). Select the frequency channel you wish to search for, and the frequency and bandwidth will be automatically selected. Press OK (**Ref.13**) to begin scanning. When the search is finished, the channel will begin playing if it has been found; otherwise the previous channel will reappear.

Multi-language and Dolby Digital broadcasting

If a channel is being broadcast in more than one audio language, you can choose which language to listen to. Similarly, if a channel is being broadcast in more than one audio format, you can choose which format to listen to.

1. Press the AUDIO button (**Ref.25**) on the remote control. The Audio setting window will appear.
2. If more than one audio language or format is being broadcast, pressing up or down (**Ref.11/Ref.14**) will cycle through the languages/formats. If a channel is being broadcast in Dolby Digital, the language will be shown with an AC3 suffix (e.g. English (AC3)). Non-Dolby broadcasts will have an MP2 suffix (e.g. English (MPEG2)).
3. Press EXIT (**Ref.4**) to close the Audio Language window and return to normal viewing.

Press MENU (**Ref.10**) on the remote control. The main menu will appear. Scroll across to select 'Picture' under the main menu using the left and right buttons (**Ref.12/Ref.32**).

Under this menu, you can change the following settings:

- **Aspect ratio** (auto, 4:3 or 16:9)
- **Resolution** (576i, 576p, 720p, 1080i or 1080p)
- **TV Format** (PAL, NTSC)
- **Video Output** (RGB, CVBS)

To change a setting, press up or down (**Ref.11/Ref.14**) until you have highlighted the setting you wish to change, then press left or right (**Ref.12/Ref.32**) until you have selected your chosen setting. To skip back a step in the menu, press EXIT (**Ref.4**).

Options

To navigate to the options section, press MENU (**Ref.10**) and scroll across until 'Options' is selected. From here you can change the following settings. Please note that audio, subtitle and audio description availability is dependent on the channel being broadcast.

- **OSD Lang:** Menu language
- **Subtitle language:** Default subtitle language
- **Audio language:** Default audio language for channel
- **Digital audio:** Select audio format on SPDIF output
- **Audio Description:** Select Audio Description settings for the blind and visually impaired. Availability dependent on channel selected.

Parent Control

The STB is shipped with a default personal identification number (PIN). The default PIN is **000000**. The PIN is required if you have enabled the parental lock. To enable Parent Control:

1. Press MENU (**Ref.10**) on the remote control. The main menu will appear.
2. Scroll across until 'System' is highlighted.
3. Scroll down to 'Parental Guidance'. Select this option, and when prompted input the password as **000000**, unless you have previously changed the PIN to a different number.
4. From here, you can change the age limit for programs. Once you have selected an age limit, watching any channel which is marked beyond this will require the PIN.

Automatic Power On/Off and Sleep

Follow this procedure to set the STB to switch on and off at specified times.

1. Press MENU (**Ref.10**) on the remote control. The main menu will appear.
2. Scroll across to select 'Time'. Select Power On/Off. From here, you can set the STB to switch on and switch off at specified times. To do this, select 'Enable' or 'Disable' for 'Power On' and 'Power Off' according to your preference. Select your preferred Power On and/or Power Off time(s) by highlighting the time and typing in your selected time using the number keypad (**Ref.20**).

You can also set the STB to sleep after a certain amount of time (between 1 and 12 hours) by selecting 'Sleep' under 'Time'.

You can upgrade the software in your STB as new versions become available. Information about the current version (and information about the hardware) is available from the menu to help you determine if you need to upgrade. This information might also be useful if you need to obtain technical support. You can also reset the STB by reinstating the default settings it had when it left the factory.

System Information

To display system information about your STB, such as the model number, software version, and hardware version:

1. Press MENU (**Ref.10**) on the remote control. The main menu screen will appear.
2. If System Settings is not highlighted on the menu, press left or right (**Ref.12/Ref.32**) until it is and then press OK (**Ref.13**). The System Settings window appears. Select 'Information' to view information relating to the model, SW version and HW version. Make a note of the information on this window if you are intending to contact us for technical support.
3. Press EXIT (**Ref.4**) or MENU (**Ref.10**) twice to return to normal viewing.

Clearing and resetting data

You can reset the STB by restoring the unit to the default settings it had when it left the factory (please see following section for instructions). This clears all channels, stations, preferences and other user settings. You will need to rescan for channels and stations before you can continue watching digital TV or listening to digital radio.

WARNING: This procedure returns the STB to its default factory settings. All data (such as time zone, channels, stations and timers) will be lost.

1. Press MENU (**Ref.10**) on the remote control to see the Main Menu.
2. Scroll across to 'System' on the menu, then press up or down (**Ref.11/Ref.14**) until you have selected 'Restore Factory Default'. Press OK (**Ref.13**).
3. A warning message will appear, asking you if you are sure you want to clear all services and reset all settings. To continue, press OK (**Ref.13**). To cancel, press EXIT (**Ref.4**).

Software Update

To update the software, please select 'FTP Download' under 'USB', 'Network Apps' in the menu.

However, if required to update the software manually, you can download the software to your PC and then transfer it to your STB. You will need a USB memory stick (not supplied with the STB).

1. Once you have obtained an upgrade file, transfer it to a USB memory stick. You need to place the file at the root (or top) level on the memory stick, not inside a folder or directory.
2. Insert the stick in the USB port. Press MENU (**Ref.10**) on the remote control, and select Software Update from the System section.

Network Settings

The network settings are automatically adjusted to the DHCP function. Under Network Settings menu, you can switch the Link Type between LAN and WiFi, and change IP Settings if required.

Network Apps

1. FTP Download

Check for software updates and update the device.

2. Weather

Displays the local and international weather forecast for the next 10 days.

3. RSS

Display of RSS feeds from major news channels such as BBC News.

4. YouTube

YouTube app for video viewing.

5. IPTV

Playback of preselected web contents. You can add your own web tv link or web radio stations. In order to receive online content, the receiver should be connected to the internet through the dsl router.

Symptoms	Possible causes	Solutions
Indicators on front panel do not light up	AC power cord is not connected	Check that the power cord is plugged into the wall socket. Make sure the power switch is on.
No picture or sound	The cables connecting the TV and the receiver are not properly connected	Make sure that the correct cable is connected between the TV and the receiver, and that the antenna is connected.
	The TV mode is not correct	Check that the correct video or AV input has been selected on your TV.
	Incorrect video definition	If you have a Composite or S-Video connection to your TV, video definition must be set to 576i. Press EXIT and then V-FORMAT on the remote control until you see a picture.
Picture and/or audio glitch	Insufficient signal strength	Check that the antenna cable is securely plugged in and that the signal is adequate.
	Electrical interference	Check that all antenna cabling is quad-shielded.
No sound	The receiver or TV is in mute mode	Press the MUTE button on the remote control and on the TV.
	Initial volume level has not been set on your TV	Select the desired TV volume level using the TV remote control.
Remote control is not working	Batteries not inserted	Insert batteries
	Batteries are flat	Change the batteries in the remote control.
	Remote control is outside the range of operation	Aim the remote control directly at the receiver.
Music files on a USB memory stick don't appear	Files are in wrong format	Check that the format is MP3.
	Files are not at the root or top level.	Move the files out of folders or directories.

MPEG Transport Stream	MPEG.4 MP@L4.0 1920 x 1080 @ 50MHz, Rate 64MHz
Maximum USB storage supported	1TB
Video Decoding	Profile level MPEG.4 MP @ L4.0 1920 x 1080 @ 50MHz, Rate 64Mbps, Input rate 80Mbps, Aspect Ratio 4:3/Letter Box/16:9/Pan & Scan, Video Resolution 1080i/p, 720p, 576p, 576i
Audio Decoding	Standard: MPEG Layer 1,2,3: Dolby AC-3, 12S S/PDIF, Channels: Single, Dual Mono, Stereo, Joint Stereo, Dolby Digital bit-streams
Main System	Main Processor: MSD 7S02E, Memory: 64Mb Flash; DDR3 1GB
USB files supported	TS, TRP, DAT, MPG, MPEG, AVI, MKV, MOV, MP4, VOB, 3PG, MP3, WMA, ACC, AC-3, E-AC-3, AAC, DTS, WAV, BMP, JPG, PNG, H.264, VC-1, DIV4/5/6
Audio & Video In/Out	HDMI: HDMI 1.4 connector (with HDCP copy protection, SCART: CVBS, RGB, S/PDIF: Coaxial Digital Audio Output, USB: USB 2.0
Power Supply	Input Voltage: 100-240V AC, Power Consumption: 18W maximum, ERP Compliant. Protection: Separate internal fuse, Switch-mode
Dimensions + Weight	W144mm x H30mm x D85 mm, weight 0.25kg, Optimum operating temperature 0-50 degrees celsius

WARRANTY

All products come with a standard 12 month warranty. All items must be registered on **www.oakcastle.co.uk** for the warranty to be valid. Once on the web page, use the menu to find "register your product". You will also be given the chance to extend your warranty for an additional 24 months, free of charge.

1. Read these instructions.
2. Keep these instructions. Instructions are also available for download at www.oakcastle.co.uk
3. Heed all Warnings
4. Follow all instructions
5. Do not clean the apparatus near or with water
6. Do not block any ventilation openings. Install in accordance with the manufacturer's instructions
7. Do not install near any heat sources such as radiators, heat registers, stoves, or other apparatus (including amplifiers) that produce heat.
8. Protect the power from being walked on or pinched particularly at plugs, convenience receptacles, and the point where they exit from the apparatus.
9. Only use attachments/accessories specified by the manufacturer.
10. Unplug this apparatus during light storms or when unused for long periods of time.
11. Refer all servicing to qualified service personnel. Servicing is required when the apparatus has been damaged in a way, such as power-supply cord or plug is damaged, liquid has been spilled or objects have fallen into the apparatus, the apparatus has been exposed to the rain or moisture, does not operate normally or has been dropped.
12. No naked flame sources, such as lit candles, should be placed on the apparatus.
13. Dispose of used electrical products and batteries safely according to your local authority and regulations.

ADDITIONAL WARNINGS

The apparatus shall not be exposed to dripping or splashing and no objects filled with liquid, such as vases, shall be placed on the apparatus. Main plug is used to disconnect device and it should remain readily operable during intended use. In order to disconnect the apparatus from the main mains completely, the mains plug should be disconnected from the main socket outlet completely. Battery shall not be exposed to excessive heat such as sunshine, fire or the like.

RECYCLING ELECTRICAL PRODUCTS

 You should now recycle your waste electrical goods and in doing so help the environment. This symbol means an electrical product should not be disposed of with normal household waste. Please ensure it is taken to a suitable facility for disposal when finished with.

IMPORTANT: Please read all instructions carefully before use and keep for future reference.

 Risk of electric shock.
Do not open

 Read all instructions carefully before use and keep for future reference

 When servicing, use only identical replacement parts



CAUTION

RISK OF ELECTRIC SHOCK
DO NOT OPEN



ATTENTION

RISQUE D'ELECTROCUTION
NE PAS OUVRIR



IMPORTANT: Please read all instructions carefully before use and keep for future reference



WWW.OAKCASTLE.CO.UK